



GV251130

Optional accessories

installation accessories

vacuuming drawer Gaggenau Minimalistic series
60 x 14 cm
GV251130

Highlights

Integrable in 14 cm high niche
Hygienic stainless steel vacuuming chamber, applicable height up to 95 mm
3 vacuuming levels for vacuuming in the chamber, max. 99%
3 vacuuming levels for vacuuming outside the chamber, max. 90%
Automatic connection recognition for vacuuming outside the chamber
Flush installation
Handleless drawer
Push-to-open function.

Application

Vacuuming for sous-vide cooking.
Vacuuming for fast marinating and flavouring.
Vacuuming for fast marinating and flavouring.
Vacuuming of vacuuming containers outside the chamber.
Vacuuming of liquids in bottles outside the chamber.

Handling

Touch key operation.

Features

Net volume 7 litres.
Capacity load max. 10 kg.
Maximum size of vacuuming bags W 240 mm x L 350 mm.
3 heat-sealing levels for different strengths of bag material.
Sealing bar, non-stick coating, removable.
Safety glass cover, opens automatically after vacuuming.
Raised vacuuming platform, 44 mm, deployable.
Utility space in vacuuming chamber, W 210 mm x L 275 mm.
Membrane for avoiding reflow of liquids during vacuuming outside the chamber.
Drying programme for vacuuming pump.

Planning notes

Plan the niche without back wall.
Protrusion from appliance front to furniture cabinet 21 mm.
Installation of GO/GS/GM/GC directly above the drawer without intermediate shelf.
Drawers installed above a dishwasher need a specific niche.
The socket can be planned behind the appliance.
Special accessories (order as spare parts):
Part No. 00578813 vacuuming bags, small
Part No. 00578814 vacuuming bags, big.

Connection

Total connected load 0.32 KW.
Connection cable 1.50 m, pluggable.

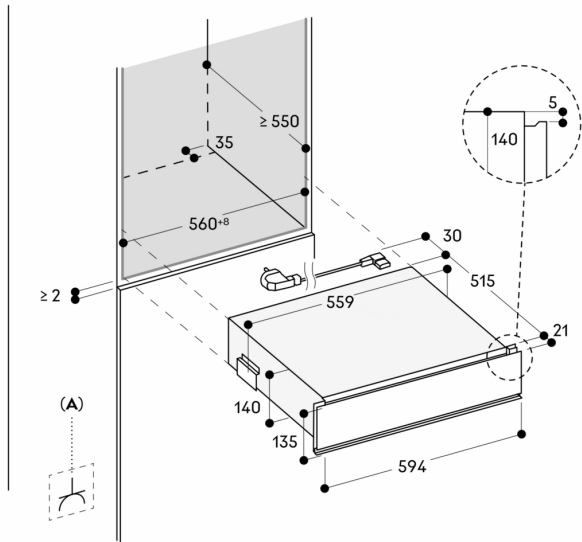

A: Accessible electrical connection
Measurements in mm